

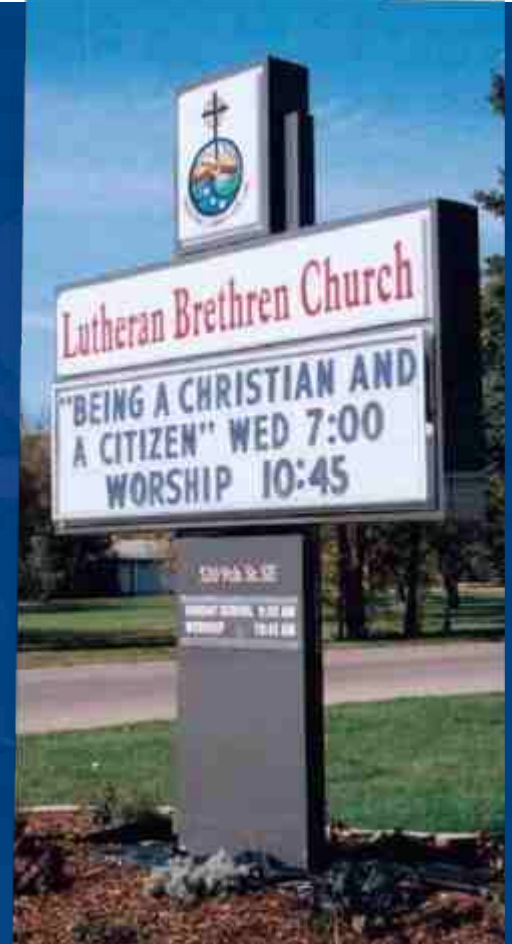

Akers
SIGN S
enhance the perception



america's leading
INSTITUTIONAL SIGNAGE
manufacturer



**Institutional
Signage Catalog**



“ December 10, 2009

Dear Potential Sign Purchaser,
My dad started Akers Signs in 1972 and I was a kid who played in a crib in my parent's sign shop. This business is in my blood, perhaps literally, from all the lead based paints used at the time. I also grew up in the church and worked as an on-staff Youth Minister for 6 years in my early 20's so I understand the needs of churches. I believe in signage as a wise stewardship choice to reach out to the local community and inform and educate them on what lies within the doors.

Whether you are making a signage purchase for a church, school, funeral home or any other business or institution, you can rest assured your business is important to us and your sign will be the best sign possible within the budget you have to work with.

Rick Akers ”



table of contents

- quality features1
- sign features2
- ECONO series3
- ECONOplus series4-5
- HEADER series6
- ICON series6
- LEDplus series7
- LED series8
- cabinet & frame colors9

- We recognize a satisfied customer is the greatest sales person we can have.
 - We design with the customers budget and objectives in mind.
- We clarify all the details before manufacturing to be certain of all that is required to satisfy the customer.
 - We recognize that everyone in our company has a contribution to make.
- Our team practices collective creativity and we are constantly improving at what we do collectively and individually.
 - We develop new and innovative products and methods that meet our customers needs and exceed their expectations.
 - We install with the requirements of safety and stability.



Signs quality features



Akers has perfected the blend of **design, materials, manufacturing processes**, and **quality control** with dedicated **craftsmanship** to produce a product of exceptional quality and value. We stand behind this product with an unmatched satisfaction guarantee. We maintain one of the highest production and delivery standards in our market.

Good design is a prerequisite to quality fabrication. Akers product designs are a unique marriage of function, structural Integrity, marketability and value. At Akers we have the experience to Incorporate market demands and manufacturing efficiencies into an effective sign design to offer the **most durable Institutional signs available**.

THE BEST MATERIALS

Years of experience have resulted in selecting only the best specialized materials. Even an exceptional design is limited in performance without equally proven raw materials. As applicable, Akers incorporates premium materials and brand name components into the sign design.

DEDICATED CRAFTSMANSHIP

Design and materials are only as good as the people behind them. Akers provides an unparalleled depth of knowledge, experience, dedication and craftsmanship.

We work closely with our suppliers for specialized staff training. From painting to testing to crating, we've gone the "extra mile" to work with our vendors to ensure the best performance from their products and services.

Certified staff painters paint according to procedures and recommended techniques of our paint supplier.

Our **certified welders** are experts at their trade to ensure product stability without sacrificing visual appeal.



PROVEN MANUFACTURING PROCESSES



We understand that performance is in the preparation. Akers has developed effective manufacturing processes that ensure the best performance in the field before our signs are painted and assembled.

QUALITY CONTROL

Akers has incorporated quality control practices over the years to ensure the consistency of our high quality standards to meet market expectations.





Signs

sign features



Unbreakable Sign Face

Faces are formed from solar grade co-extruded polycarbonate to resist damage from impact and yellowing due to sunlight.

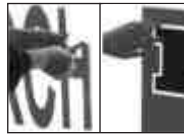

Second Surface Decoration

3M high performance vinyl is applied second surface (inside the face) protected both from vandals and the elements.

Fiberglass Decorative Trim

Gives a smooth, three-dimensional finished look.

Not available in all sizes.



Graffiti-Resistant Paint

Paint is baked on at 180°; graffiti can easily be wiped away.



Locking Vandal Cover

A keyed locking vandal cover system keeps vandals from getting access to the message.



Easy Copy Changes

Self-supporting mechanical props, support the vandal cover opening to 90° for ease of message changes.

Planked Face

Planking in the face adds rigidity to keep the face from sagging and allows air, water and debris to flow through.



Riveted Copy Track

Rivets hold stronger than glue and in combination with the planking allow for easy cleaning.



Strong Structure

Engineered for strong wind loads to accommodate zoning regulations.



Signs **ECONO** series



The most popular series for size and value.

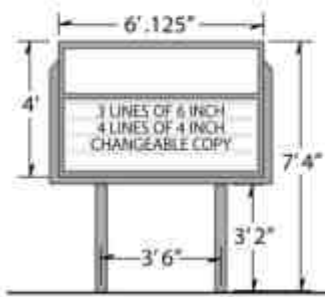

ECONO 46

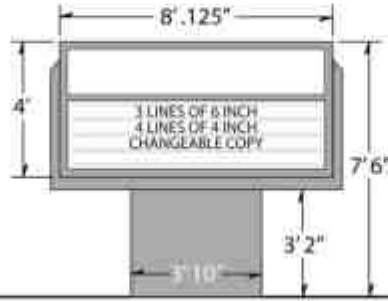

ECONO 48

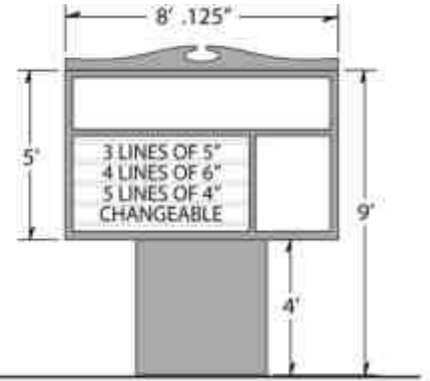

ECONO 58

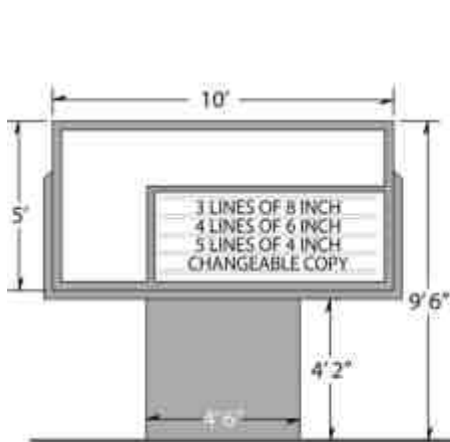

ECONO 510

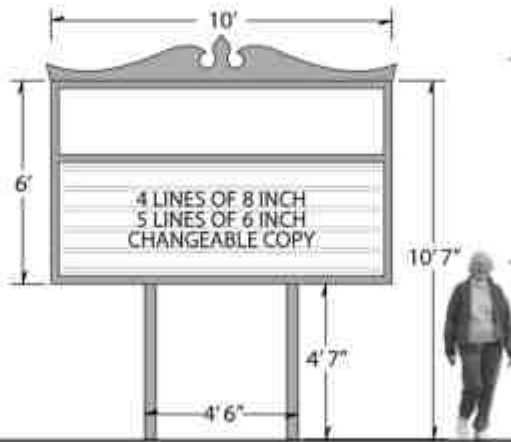

ECONO 610

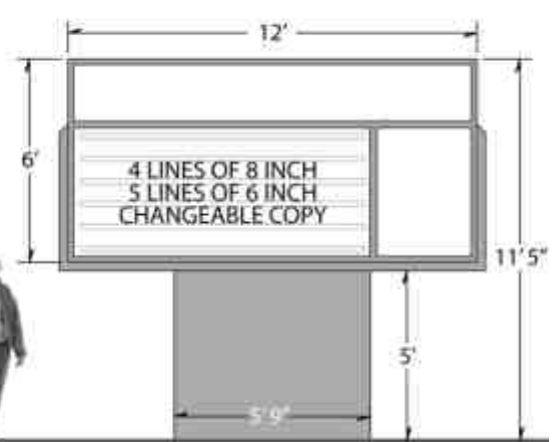

ECONO 612

COWLING OPTIONS

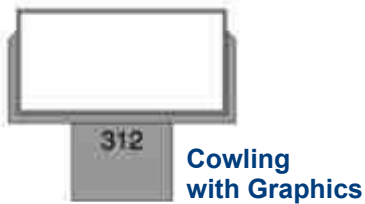
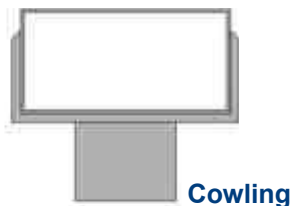

DECORATIVE TRIM OPTIONS

Manufactured with fiberglass in 6' and 8' lengths.

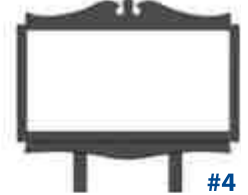
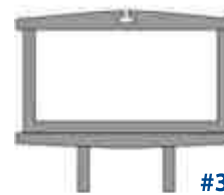
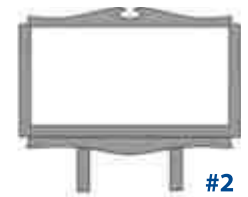
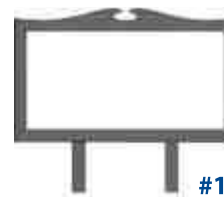



SignECONOplus series

Akers has taken the best from our institutional product line and put together a competitively-priced, new sign series with our customer needs in mind. You choose the cabinet size, face and mounting option. Akers has done the rest.

PEDESTAL MOUNT

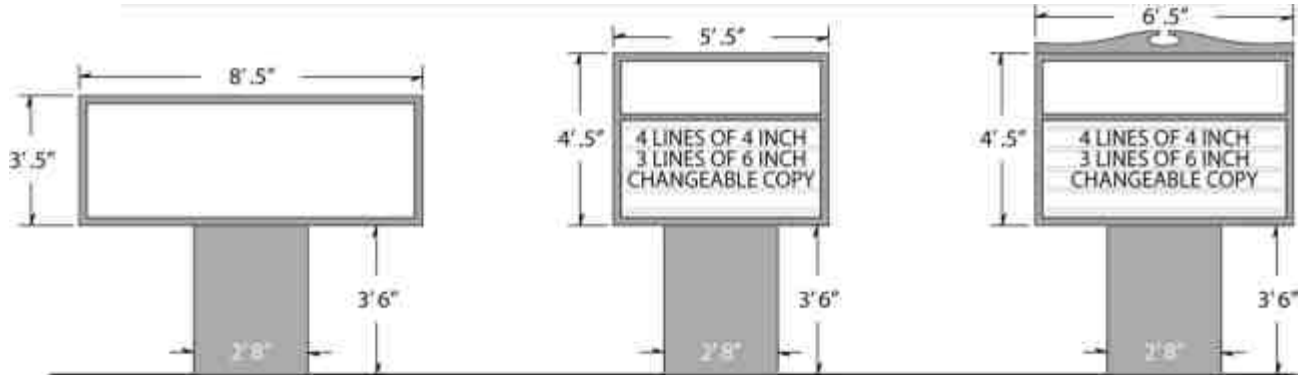

ECONOplus P38

ECONOplus P45

ECONOplus P46

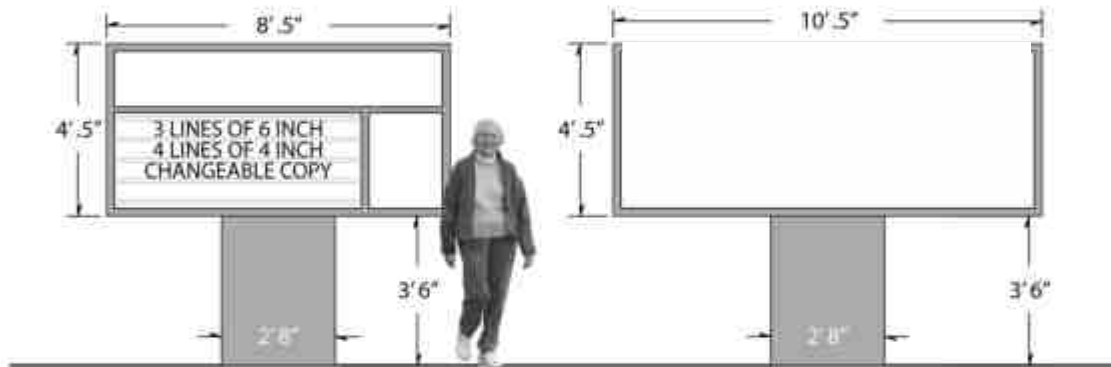

ECONOplus P48

ECONOplus P410

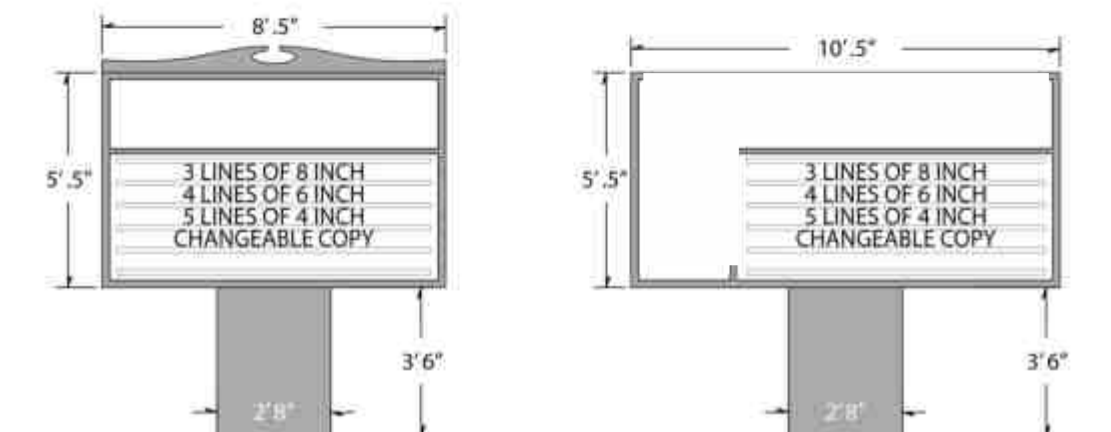

ECONOplus P58

ECONOplus P510

Signage **ECONOplus series**



MONUMENT MOUNT

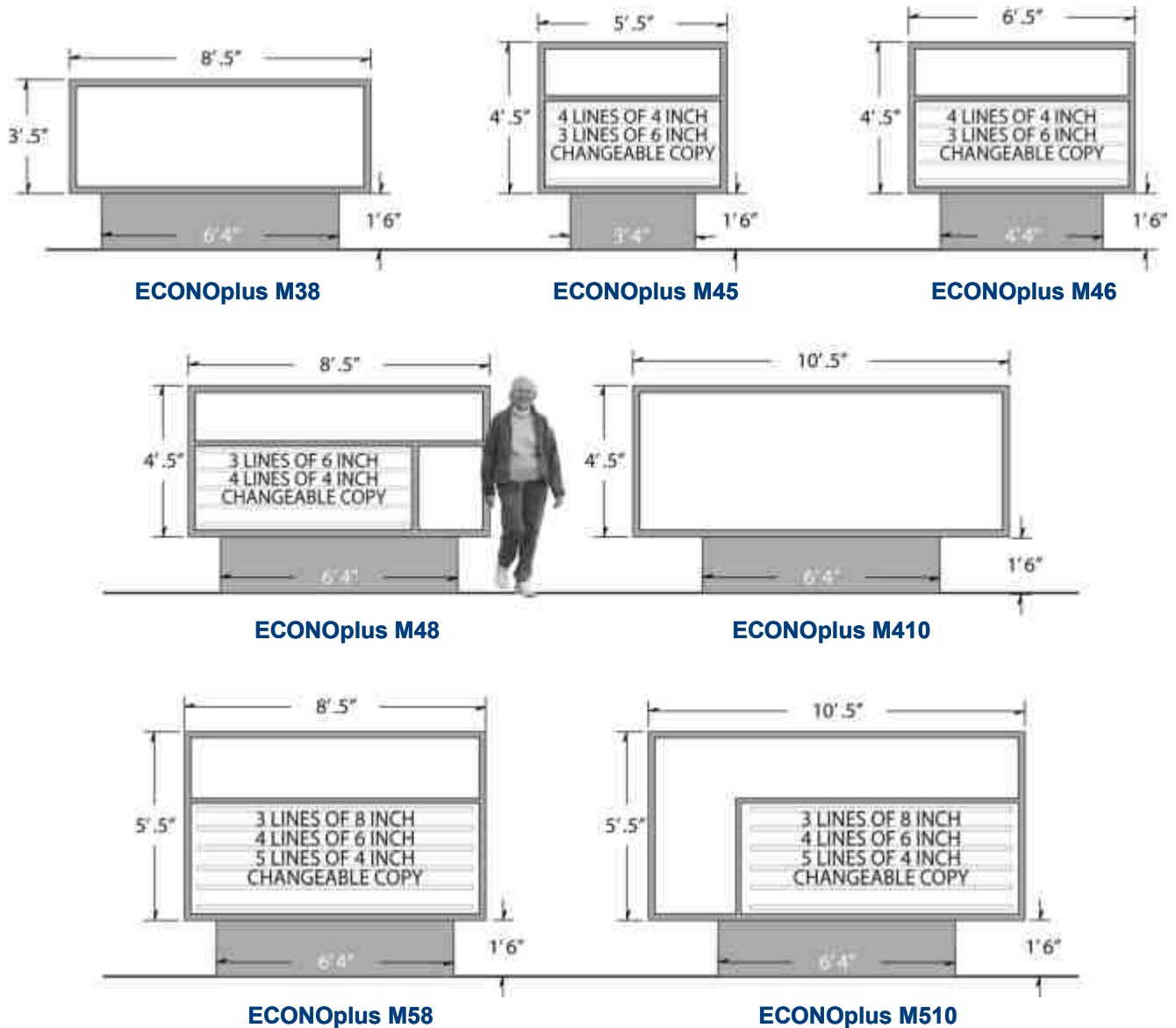

MONUMENT MOUNT

FACE OPTIONS

Face option availability may be limited by size restrictions. Please contact Akers for more information.



- Header/Logo Combined**
- 4 x 6 / 8
 - 5 x 8 / 10
 - 6 x 10

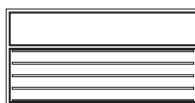

- Extended Message Area**
- 4 x 5 / 6 / 8
 - 5 x 8 / 10
 - 6 x 10



- All Identification**
- 3 x 5 / 6 / 8 / 10
 - 4 x 5 / 6 / 8 / 10 / 12
 - 5 x 8 / 10 / 12
 - 6 x 10 / 12



- All Message Area**
- 2 x 6 / 8
 - 3 x 3.5 / 8
 - 4 x 5 / 6 / 8
 - 6 x 10 / 12



- Inverted Face**
- 4 x 6 / 8
 - 5 x 8 / 10
 - 6 x 12

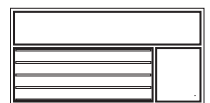

- Header / Logo Separate**
- 4 x 6 / 8
 - 5 x 10
 - 6 x 10 / 12



Signs **HEADER** series

This series stacks up two levels of information for **double impact**. The separation of the panels adds **size and definition** to the sign.

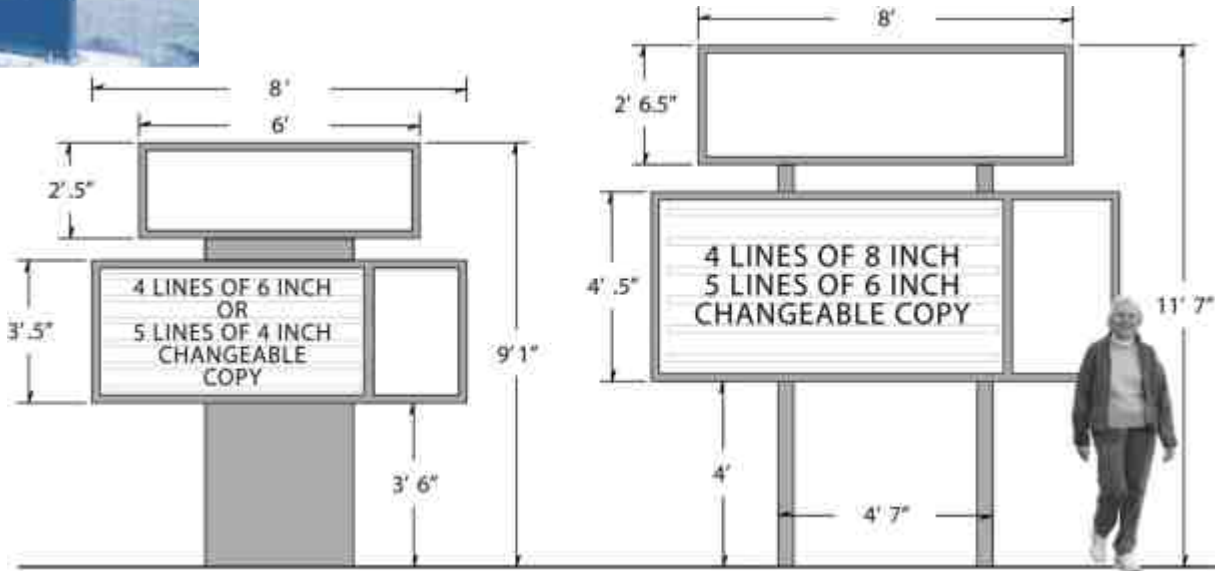

HEADER 38

HEADER 410

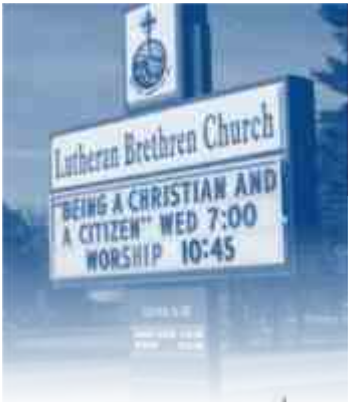

Signs **ICON** series

Distinctive and eye-catching... grabs the viewer with a prominent icon.

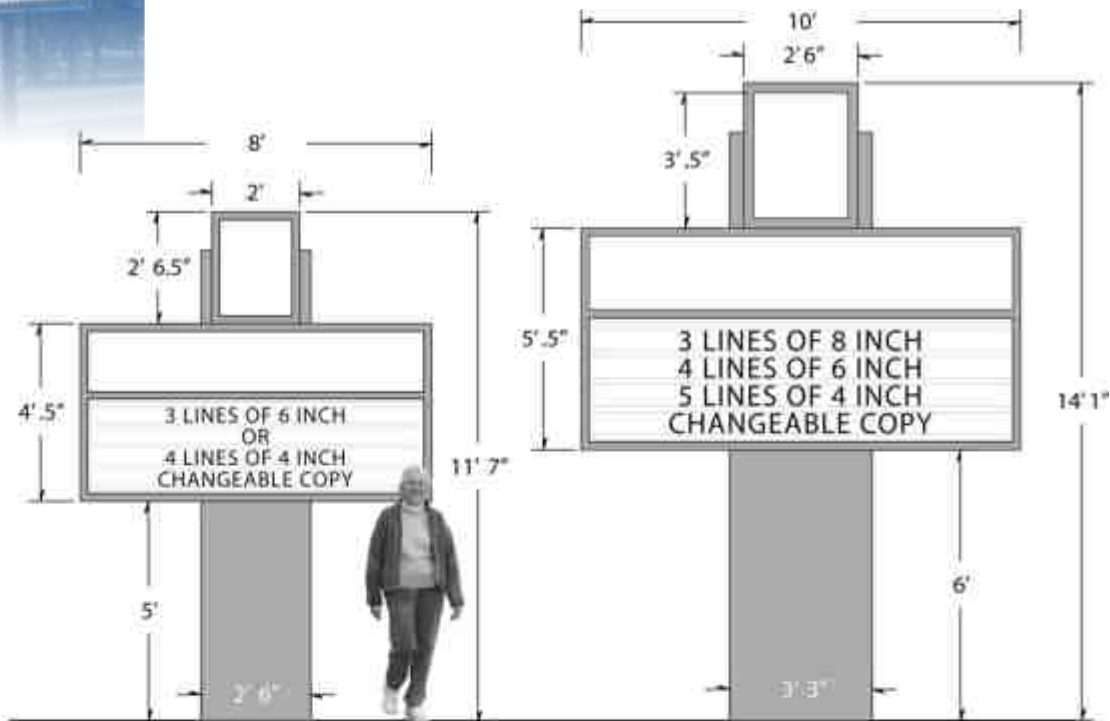

ICON 48

ICON 510

Signs LEDplus series



LED Message Centers

This series is dynamic with an integrated Electronic Message Center. Program your message to change throughout the week or day. LED units available in red, amber or full color.

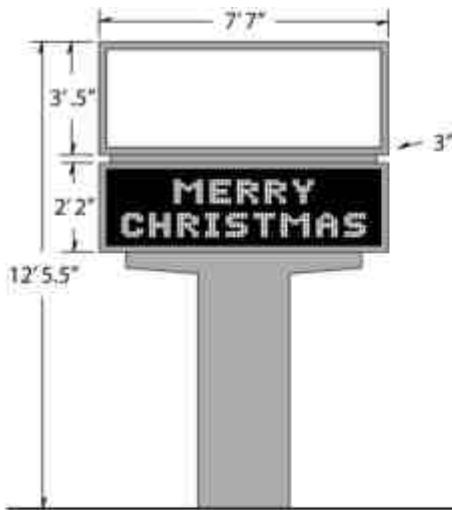

LEDplus 664



LEDplus 680

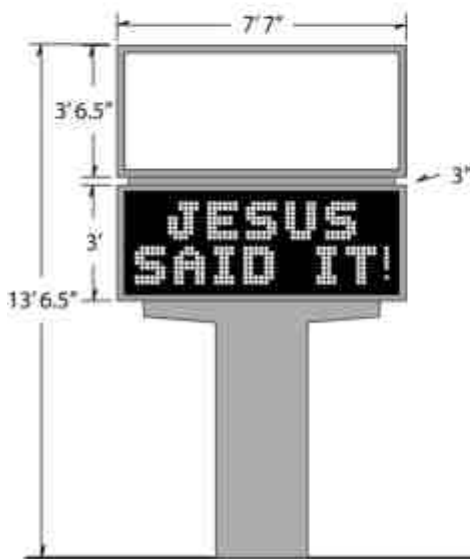

LEDplus 2464

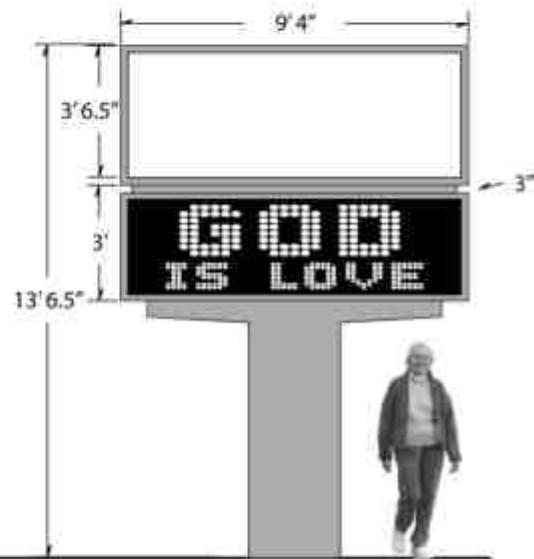

LEDplus 2480

MATRIX CONVERSION NOTES: 16 X 64 and 16 x 80 Matrix = 2 lines of 9" or 1 line of 21"
24 x 64 and 24 x 80 Matrix = 3 lines of 9", 2 lines of 15" or 1 line of 32"

Signs

LED series

By incorporating an electronic message center within Akers quality constructed seamless cabinet, a unique sign offering has been introduced into the marketplace.

All IMC units are available as either a pedestal, angle bracket or wall mount units.

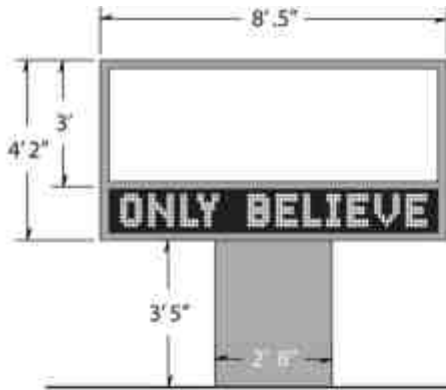

LED 48-864



LED 48-1664

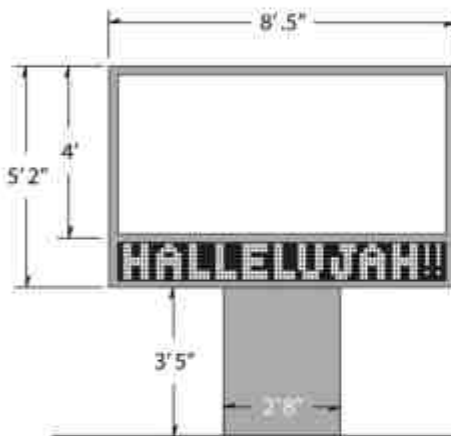

LED 58-864



LED 58-1664

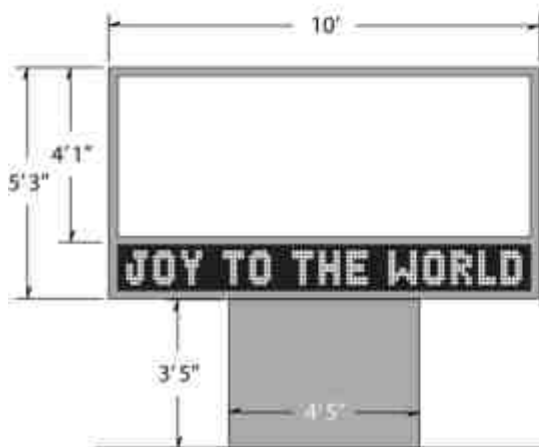

LED 510-880



LED 510-1680

MATRIX CONVERSION NOTES: 8 X 64 and 8 x 80 Matrix = 1 line of 9"
16 x 64 and 16 x 80 Matrix = 2 lines of 9", 1 lines of 21"

Signs economy LED



Unique Features

- Ultra-bright LED's for high visibility
- 9 brightness settings
- Message scheduling
- Password protection
- Auto time / date
- Display text horizontally or vertically
- 345 pre-programmed animated graphics
- 38 character functions
- 32 different character effects
- English, Japanese, and Korean characters

ODM Program

- Modular system design
- Custom sized LED module
- Industrial sized power supplies & PCB
- Custom vibration resistant frame
- Vibration proof IC0B
- 3 year warranty
- Next Day UPS service

Standard Placement Options*

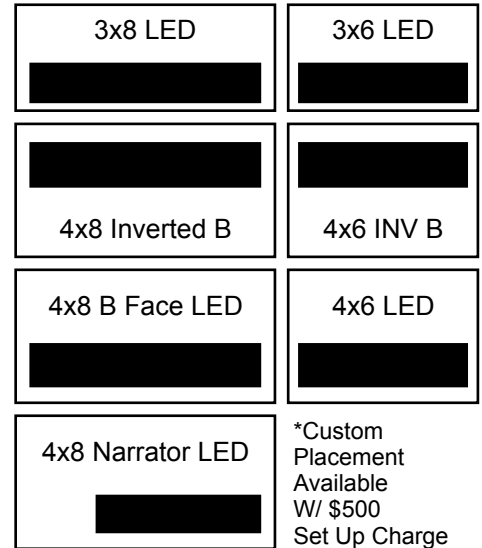

Choose from one of our standard placement options above, or use a custom placement. Call for Pricing on the configuration that best fits your Churches needs

LED Specification	ML-3225RG	ML-4225RG
LED Size (mm)	5	5
Type of Construction	Oval	Oval
Horizontal Viewing Angle	140	140
Vertical Viewing Angle	40	40
Brightness MCD	3000	3000
LED Lens	Frosted	Frosted
Display Specifications		
Type of Illumination	LED	LED
LED Color	Red/Green	Red/Green
Type of Green	Pure Green	Pure Green
No. of LED/Pixel	2	4
Pitch (mm)	20	26.25
Module Height (mm)	320	420
Module Width (mm)	320	420
Module Matrix Height	16	16
Module matrix Width	16	16
No. of Modules	5	5
Sign Matrix Height	16	16
Sign Matrix Width	80	80
Viewing Area Height (mm)	320	420
Viewing Area Width (mm)	1600	2100
Max. Line of Text	2	2
Max Character Height (mm)	320	420
Double Line Character Height (mm)	140	183.75
Display Lens	None	None
CPU Specification		
Memory		
Preprogrammed Animations and Graphics	345	345
Font Types	38	
Special Effects	32	
No. of Languages	3	
Run Horizontally or Vertically	Yes	
Time	Included	Included
Temp	Included	Included
Electrical Specification		
Power Input	120VAC	120VAC
Power Supply Output	5VDC	5VDC
Amperage	20A	20A
Power Supply Max. Wattage	100W	100W
Power Supply Manufacturer	Meanwell	Meanwell
Certification	UL	UL
Programming Device Options		
Wireless Keyboard	IR Keyboard	IR Keyboard
Computer	RS232	RS232



4x8 B Face LED



Sign cabinet & frame colors



Akers offers an array of color choices for each sign. These are standard **cabinet, frame, and face colors**. Custom colors, stucco, and knockdown finishes are also available.

STANDARD CABINET AND FRAME COLORS

Cabinet and frame structures are finished with thermally cured premium PPG Delta™ graffiti resistant industrial coatings.

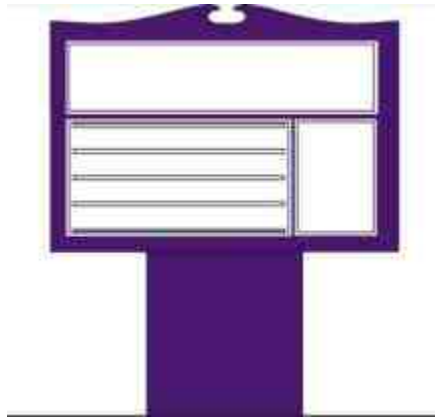

White DGHS: DAR-8000	Black DGHS: DAR-9000 PMS: Process Black	Dark Burgundy DGHS: 51049 PMS: 188C	Dark Green DGHS: 44932 PMS: 3308C	Purple Dawn DGHS: 50785 PMS: 2627C	Turquoise DGHS: 15006 PMS: 3155C
Orange DGHS: 60913 PMS: 166C	Neon Yellow DGHS: 80018 PMS: 124C	Chestnut DGHS: 26131 PMS: 469C	Caramel DGHS: 27437 PMS: 728C	Antique Bronze DGHS: 29049 PMS: 405C	Pewter DGHS: 32341 PMS: Cool Grey 11C
Flag Red DGHS: 72355 PMS: 485C	Royal Blue DGHS: 16606 PMS: 274C	Silver Grey DGHS: 34615 PMS: 430C	Seascape Blue DGHS: 18116 PMS: 299U	Bonnie Blue DGHS: 12908 PMS: 282C	Light Beige DGHS: 27440 PMS: 468C

NOTE: Bonnie Blue is a lighter shade than Royal Blue

STANDARD TRANSLUCENT FACE COLORS

3M™ high performance vinyl graphics are digitally cut and applied to the inside of the translucent ultraviolet-resistant solar grade polycarbonate sign face..

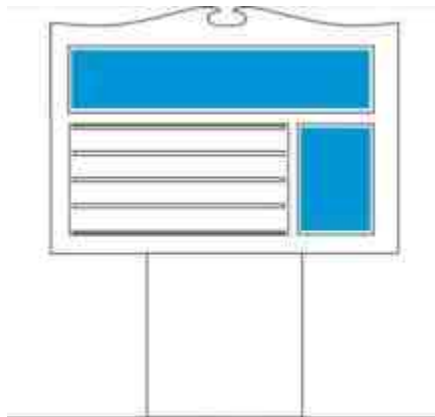

White 3630-20	Black 3630-22 PMS: Process Black C	Burgundy 3630-49 PMS: 188C	Green 3630-26 PMS: 349C	Dark Brown 3630-59 PMS: 4625C	Sunflower 2630-25 PMS: 123C
Orange 3630-44 PMS: 1655C	Olympic Blue 3630-57 PMS: 2925C	Holly Green 3630-76 PMS: 3425C	Bright Blue 3630-167 PMS: 2945C	Durandonic 3630-69 PMS: Black C	Yellow 3630-015 PMS: 109C
Dark Red 3630-73 PMS: 193C	Teal Green 3630-246 PMS: 322C	Plum Purple 3630-128 PMS: 2622C	Royal Blue 3630-87 PMS: 274C	Blue 3630-36 PMS: 281C	Light Beige 3630-109 PMS: 468C

Note: Due to the limitations of printers and monitor setting variations, the color samples shown are only approximations of true paint and material colors.



trust

quality

experience

strength

value

AKERS is a Partner

Effective signage is essential for every business or institution. At Akers we take pride in the partnership we have with our customers, consistently **delivering quality signs** at the value customers expect. We have earned your trust and will deliver more that you expect. Thank you for partnering with Akers.

AKERS delivers quality

Akers has been a leader in the production of illuminated signage. For almost two decades, we have been developing and manufacturing a line of turnkey signage designed for the institutional market that is superior.

- Quality and manufacturing standards are unmatched.
- Customer service is friendly and dependable.
- Manufacturing is both innovative and cost effective.

AKERS has the expertise

Akers has built **hundreds of institutional signs**. In fact, there is an entire production facility dedicated only to institutional signage and the quality standards to meet market demands. Akers is continually improving the options and customization for this speciality line. Akers is the expert in institutional signage. You can expect to be the best.



2001 Allen Avenue SE,
Canton, Ohio 44707
1-888-456-6990
www.akerssigns.com
www.customchurchsigns.com